

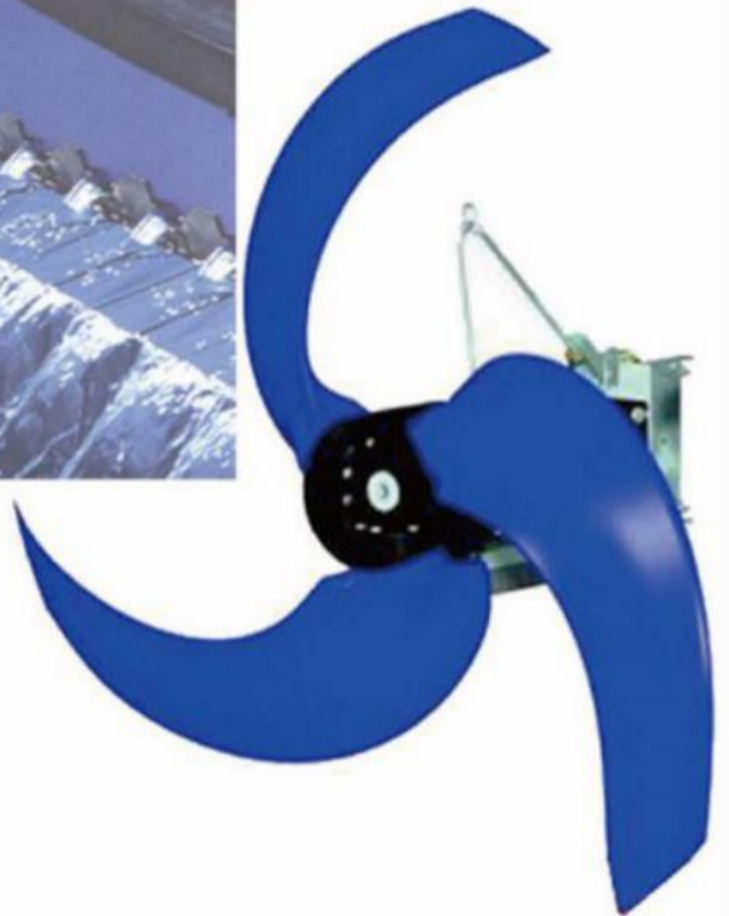

潜水推流器

Submersible Flow Propeller



QDT型潜水推流器

QDT Type Submersible flow propeller

QDT型潜水推流器，在水处理工艺流程中，广泛应用于氧化沟推流，各类生化池的搅拌，同时也可用于河流防冻，景观水循环等。低速推进器由潜水电机、减速装置、叶桨和安装系统等组成。其特点是配套功率小（1.5-9KW），转速低（34-85r/min），叶桨直径大（1100-3000mm），产生大体积流场，服务范围广。后掠式香蕉型叶桨设计，具有自洁功能，采用聚氨脂或增强玻璃钢成型，具有重量轻、强度高、耐腐蚀等优点，其优异的水力性能，可保证在低速的运动状态下与液体产生良好的阻尼效果，从而创建出柔和的水流。该系列产品除了具有推流和创建水流的作用外还具有搅拌功能。如图。



QDT type Submersible flow propeller is extensively used for the oxidizing flow propelling and agitation in various types of biochemical tanks during the water treatment process, also can be used for river frost protection and, landscape water circulation etc.. The low-speed flow propeller consists of submersible motor, speed-reducing device, blades, and installation system etc. The product is characterized by low power (1.5-9KW), low rotate speed (34~85rpm), large diameter of the blades (1100-3000mm), low-speed rotation, production of large-volume flow field and wide scope of service. The sweptback, banana-shaped blades have self-cleaning function, which is finishing cast with PU or glass fibre reinforced plastics and highlighted by light weight, high strength, and good anticorrosion etc. The excellent frictional property can ensure the a good damping effectiveness with the fluid in low speed movement status to produce gradual water flow. Besides the flow propelling and producing water flow, this series of products also have mixing function as shown in the drawing.

QDTA型潜水推流器是我公司自主研发替代QDT型的改进型产品，其特点是低能耗、大推力。在保障主机可靠性的前提下，选配高效率的减速装置，丰富机型配置，提高输出功率，并使运行更加平稳；在叶桨的设计上由原来的“香蕉型”叶桨改为“阔叶型”叶桨。改进后的QDTA型叶桨比传统QDT型叶桨的比表面积提高1/3，同时采用法兰式叶桨定位，比原有柱销式要更加精确可靠，在同等推流能力下，实现节能30%以上。其中改进后的三叶型推流器，在同等转速及叶桨直径条件下，推流能力提高20%以上，同时具备可靠性高、稳定性强的特点，为工程应用提供了更加丰富的选择。



QDTA type low speed flow propeller is developed and improved by ourselves to replace QDT type products, it is characterized by low energy consumption and large thrust. On the premise of ensuring the mainframe reliable, firstly the speed reducer selects a high efficiency one, the output power is improved, and running is more smoothly; secondly the blade design has been changed from broad leave type to banana type, the specific surface area of QDTA blade enlarged 1/3 comparing with QDT blade after improvement, furthermore, the flange blade positioning is more precise and reliable than the old pin type, the thrust increased 30% Which improved QDTA type using three vanes, in the same conditions of speed and blade turbine diameter, the plug-flow capacity increased by 20% or more, along with high reliability, stability and strong features for engineering applications to provide a more extensive selection than the original type without increasing the matching power. This shows that the effectiveness of QDTA propeller is obviously improved after improvement, which has been a proffered product among the congener equipments.

使用条件 Conditions of Application

为了保证潜水推流器的正常工作，请正确选择工作环境和运行模式。

In order to ensure the normal operation of the submersible mixer, please make correct selection of the operating environment and the operating modes.

最高介质温度不超过40℃；

The highest temperature of the medium shall not exceed 40℃；

介质的pH值范围：5~9；

The scope of pH value of the medium:5~9；

介质密度不超过1150Kg/m³；

The density of the medium shall not exceed 1150Kg/m³；

潜水深度不超过20m。

The depth of submersion shall not exceed 20m.

▲特别提示：潜水推流器必须完全潜入水中工作，不能在易燃易爆和强腐蚀性及高温的环境中工作。针对特殊环境下的要求，我公司可为用户提供特殊设计。

▲Special Warning: The submersible mixer must completely submerge in the water and cannot operate in the inflammable, explosive, highly corrosive and high-temperature environment. In line with the requirement of the special environment, our company can provide special design for the users.



桨叶由弹性聚氨酯或增强玻璃钢制成，能承受变化的负荷，推力被平均分配到混合物上，具最佳水力设计
The blades are made of elastic PU or glass fibre reinforced plastics, can bear varying load, the propelling force is equally distributed to the mixture and the waterpower design is optimized.

法兰式的叶桨定位，更加精确可靠
Flange type blade positioning is more precise and reliable

两套独立的密封，保证潜水电机长期可靠运行
The two rows of independent mechanical sealing ensure a long-term and reliable operation of the submersible motor

独特的电缆密封设计排除了电缆漏水的隐患
The unique sealing design for the cables avoids hidden danger of water infiltrating to the cables

所有接触介质的紧固件均采用不锈钢材质
All fasteners for the contact medium employ stainless-steel material

高效率，长寿命斜齿轮减速装置
High efficiency helical gear speed-reducing device and with long life

高质量进口一次性润滑轴承，设计使用寿命100,000小时
The imported high-quality one-time lubricated bearings have designed service life of 100,000 hours

内部设有泄漏传感器和定子绕组超温保护报警装置
The leakage sensor and winding stator over-temperature alarming device are in built.

应用范围 Scope of Application

潜水推流器主要运用在市政和工业污水处理过程中的混合、搅拌和环流，也可用作景观水循环的推流设备，通过搅拌达到创建水流作用，有效阻止悬浮物沉降。

The submersible mixers are mainly used for mixing, agitating and making ring flows in the process of municipal and industrial sewage treatment and can also be used for equipment maintenance of the landscape water circulation; through agitation, they can achieve the function of creating water flow, improving water quality, increasing oxygen content in the water and effectively preventing the sedimentation of the suspended substances.



型号表示方式 Model of Model Denotation

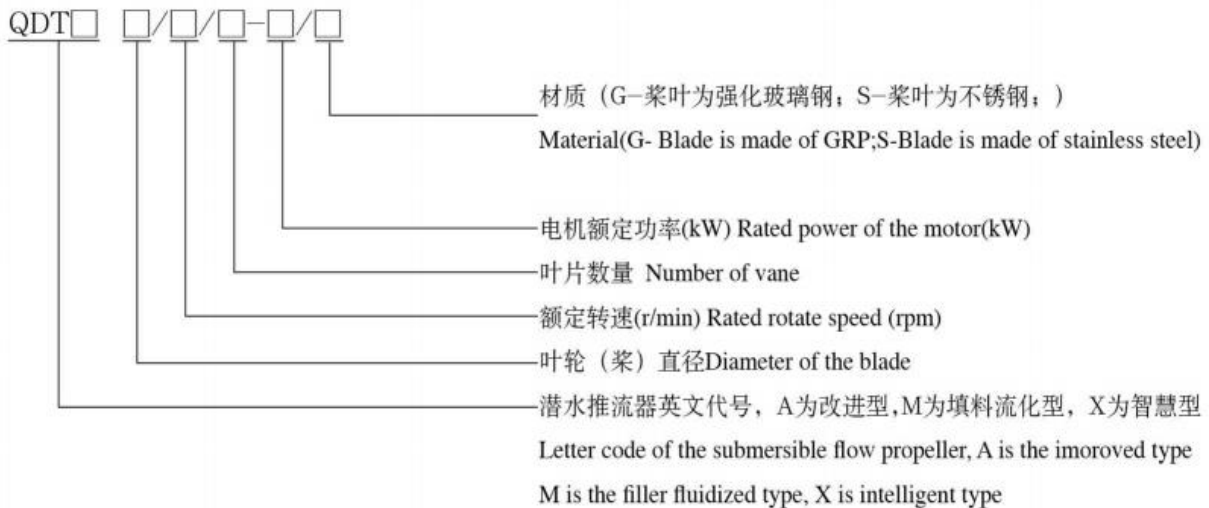

性能参数 Performance Parameters

型号Model		电机功率 (kW) Motor power	额定电流 (A) Rated current	叶轮转速 (r/min) rpm of impeller	叶片数量 (set) Num. of vane	叶轮直径 (mm) Diameter	推力 (N) Thrust	重量 (Kg) Weight
标准型 Standard model	QDTA1100/52/2-2.2/G	2.2/4	4.9	52	2	1100	1100	169
	QDTA1100/63/2-3/G	3/4	6.6	63	2	1100	1500	171
	QDTA1100/85/2-4/G	4/4	8.6	85	2	1100	1840	178
	QDTA1400/34/2-2.2/G	2.2/4	4.9	34	2	1400	1430	196
	QDTA1400/43/2-3/G	3/4	6.6	43	2	1400	1870	198
	QDTA1400/52/2-4/G	4/4	8.6	52	2	1400	2150	205
	QDTA1400/63/2-5.5/G	5.5/4	11.3	63	2	1400	2740	208
	QDTA1800/34/2-3/G	3/4	6.6	34	2	1800	2040	205
	QDTA1800/43/2-4/G	4/4	8.6	43	2	1800	2710	212
	QDTA1800/47/2-5.5/G	5.5/4	11.3	47	2	1800	3320	308
	QDTA1800/52/2-7.5/G	7.5/4	15.5	52	2	1800	4010	312
	QDTA2100/34/2-3/G	3/4	6.6	34	2	2100	2150	203
	QDTA2100/43/2-4/G	4/4	8.6	43	2	2100	2600	210
	QDTA2100/47/2-5.5/G	5.5/4	11.3	47	2	2100	3350	306
	QDTA2100/52/2-7.5/G	7.5/4	15.5	52	2	2100	3900	310
	QDTA2500/34/2-3/G	3/4	6.6	34	2	2500	2500	207
	QDTA2500/43/2-4/G	4/4	8.6	43	2	2500	3200	214
	QDTA2500/39/2-5.5/G*	5.5/4	12	39	2	2500	3840	322
	QDTA2500/43/2-7.5/G*	7.5/4	15.5	43	2	2500	4280	326
	QDTA1100/52/3-3/G	3/4	6.6	52	3	1100	1600	177
	QDTA1100/85/3-5.5/G	5.5/4	11.3	85	3	1100	2320	187
	QDTA1400/43/3-4/G	3/4	6.6	43	3	1400	1870	210
	QDTA1400/52/3-5.5/G	7.5/4	15.5	52	3	1400	3300	213
	QDTA1800/34/3-4/G	3/4	6.6	34	3	1800	2040	222
	QDTA1800/43/3-5.5/G	5.5/4	12	43	3	1800	3320	306
	QDTA1800/52/3-7.5/G	7.5/4	15.5	52	3	1800	4010	310
	QDTA2100/34/3-4/G	4/4	8.6	34	3	2100	2550	219
	QDTA2100/43/3-5.5/G	5.5/4	11.3	43	3	2100	3320	303
QDTA2100/47/3-7.5/G	7.5/4	15.5	47	3	2100	4030	307	
QDTA2500/43/3-5.5/G	5.5/4	12	43	3	2500	3840	312	
QDTA2500/47/3-7.5/G	7.5/4	15.5	47	3	2500	4280	331	

注： 1、电机绕组绝缘等级：F级，防护等级：IP68，电机工作制式：24小时连续工作。
2、可提供H级绝缘电机。

Notes: 1、Winding insulation class of the motor: Class F; Protective grade; IP68; Operating mode :Operation for 24 hours
2、We can supply the motor with class H winding insulation

选型参考 Reference for Type Selection

潜水推流机的选型是一项比较复杂的工作，选型方案的正确与否直接影响到设备的正常使用，作为选型的原则就是要让推流机在适合的容积里发挥充分的推流功能，这个标准一般可用流速来确定。根据污水处理厂的不同工艺要求，搅拌机选型的最佳流速应保证在 $0.15\sim 0.3\text{m/s}$ 之间，如果低于 0.15m/s 的流速则达不到推流搅拌的效果，如果超过 0.3m/s 的流速则会影响工艺效果且造成浪费。所以在选型前，首先要确定潜水推流机运用在什么场所，如：污水池、污泥池还是生化池；其次是介质参数，如：悬浮物含量、温度、PH值等；还有水池的形状，水深甚至安装方式等都将对选型产生影响，同时还应考虑到节能因素，因为这将会影响到用户今后的运行成本。

为了满足不同环境下都能达到最佳的推流效果，我们为用户提供了多种型号的潜水推流机，同时可提供选型服务。可参考下面的潜水推流机流场图。



The type selection of submersible mixer is a rather complicated job. The correctness of the type selection will directly affect the normal usage of the equipment. The principle for the type selection is to enable mixer to give full play to its mixing function in the appropriate volume. This standard can generally be determined by the flow velocity. In line with the different technological requirement of the sewage treatment, the optimum flow velocity for the mixer type selection shall ensure the velocity range of $0.15\sim 0.3\text{m/s}$. In case of the flow velocity lower than 0.15m/s , the effectiveness of agitation or mixing can not be achieved. In case of the flow velocity bigger than 0.3m/s , the technological effectiveness will be affected and waste will be caused. Therefore, before type selection, it is necessary to determine what kind of environment the mixer will be used in, for instance, sewage tank, slag pond or biochemical pond. Secondly, the parameters of the medium such as content of the suspended substances, temperature, pH value as well as the shape of the pond, water depth and even the mode of installation and so on will all influence the type selection. Meanwhile, it is also necessary to consider the energy-saving factor, because this will influence the operating cost of the users in the future.

For the purpose of fulfilling the optimum mixing function in different environments, we can supply multiple types of the submersible mixers to the users and provide type selection service as well. Refer to the following diagrams of the flow field of submersible mixer.



潜水推流器流场图 Diagrams of the Flow Field Submersible flow propeller

该流速场是在清水中边界流速 $V=0.1\text{m/s}$

This flow velocity fields are located in the clear water with the boundary water flow velocity of $V=0.1\text{m/s}$

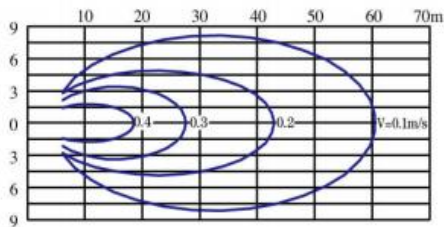

QDTA1100/52/2-2.2/G, QDTA1400/34/2-2.2/G

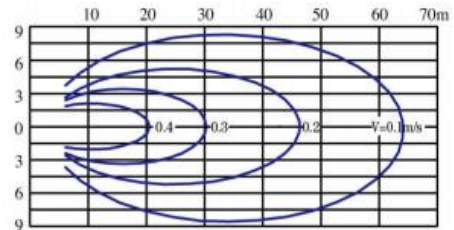

QDTA1100/63/2-3/G, QDTA1100/52/3-3/G

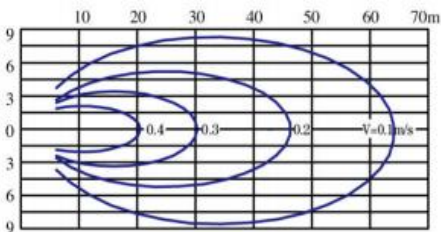

QDTA1400/43/2-3/G

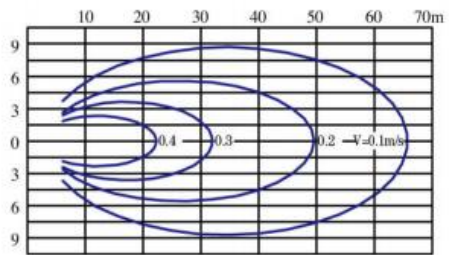

QDTA1400/52/2-4/G, QDTA1400/43/3-4/G,
QDTA1100/85/2-4/G

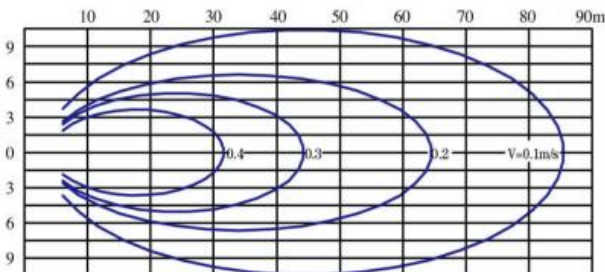

QDTA1100/85/3-5.5/G, QDTA1800/34/3-4/G

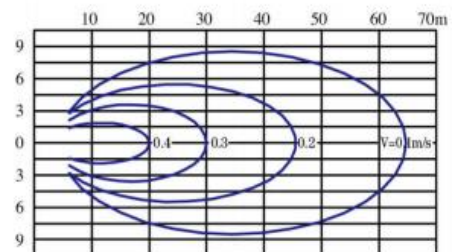

QDTA1800/34/2-3/G, QDTA2100/32/2-3/G
QDTX1800/43/3-3/S

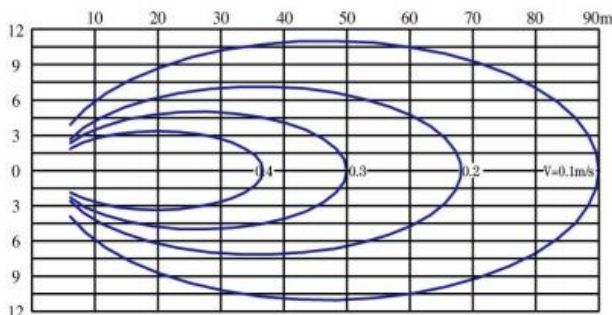

QDTA1400/63/2-5.5/G, QDTA1400/52/3-5.5/G

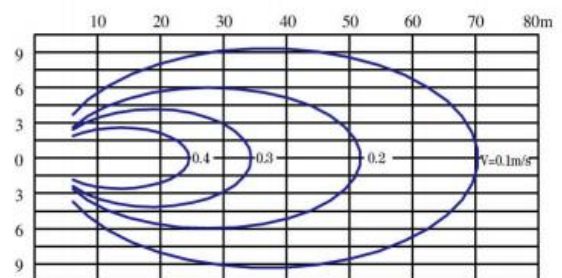

QDTA1800/43/2-4/G, QDTA1800/43/3-4/G,
QDTA2100/43/2-4/G, QDTX1800/43/3-4/S

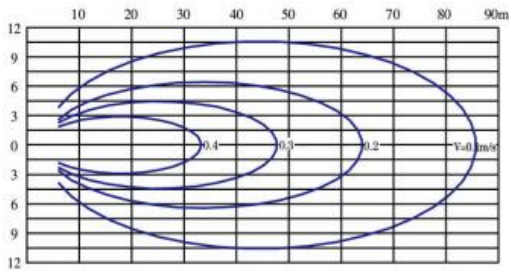

QDTA1800/47/2-5.5/G QDTA2100/47/2-5.5/G

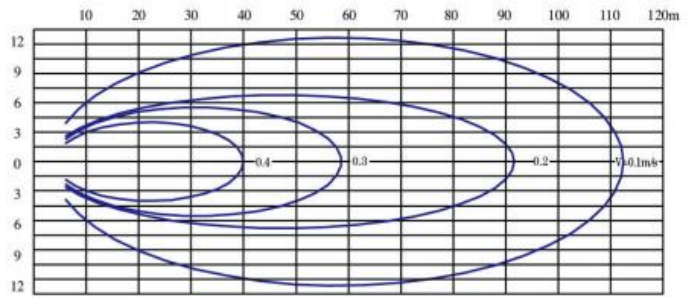

QDTA1800/52/2-7.5/G QDTA2100/52/2-7.5/G

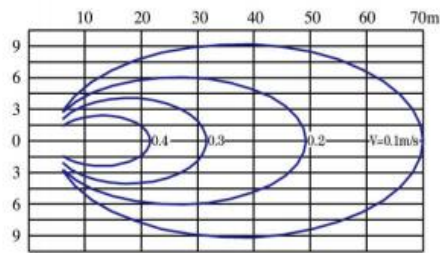

QDTA2500/34/2-3/G, QDTA2100/34/3-4/S

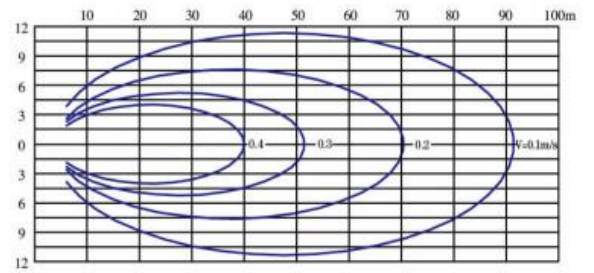

QDTA1800/43/3-5.5/G

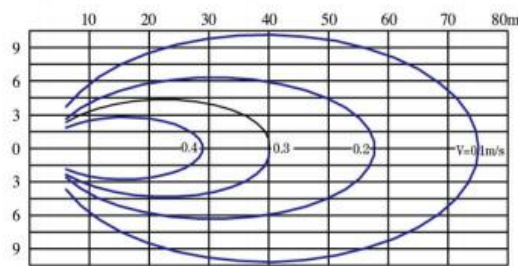

QDTA2500/43/2-4/G, QDTX2300/43/3-4/S

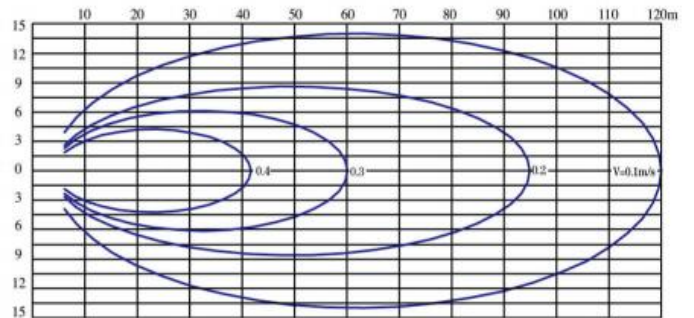

QDTA1800/52/3-7.5/G, QDTA2100/47/3-7.5/G

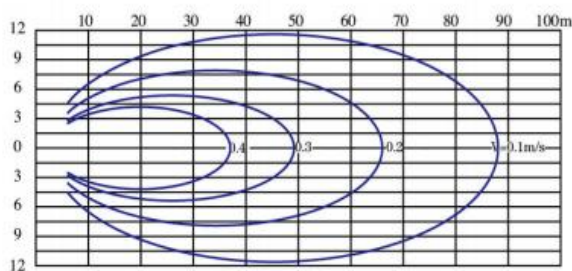

QDTA2100/43/3-5.5/G, QDTX2300/43/3-5.5/S

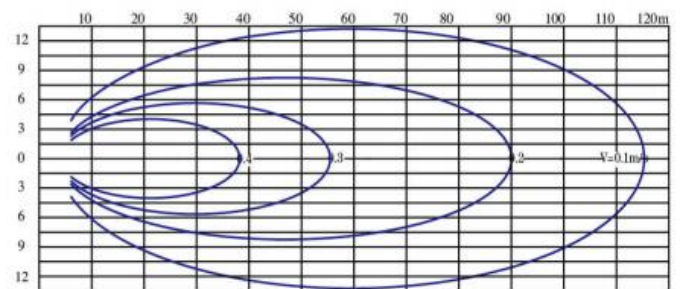

QDTA2100/52/2-7.5/G, QDTX2300/43/3-7.5/S

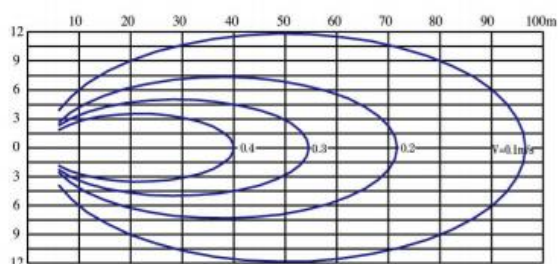

QDTA2500/39/2-5.5/G*, QDTA2500/43/3-5.5/G

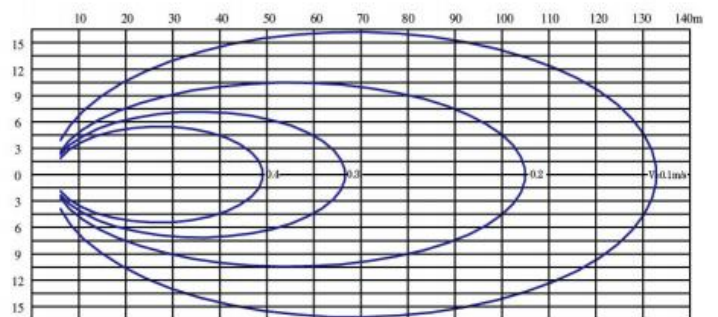

QDTA2500/43/3-7.5/G, QDTA2500/43/2-7.5/G*

潜水推流器运行模式 Operating Modes of Submersible flow propeller

潜水推流器的安装定位对其搅拌效果有很大的影响，为了达到预期的运行效果，我们建议用户按照专业设计人员的要求去做，要充分考虑到水池的形状，进出水的位置以及搅拌机的水流反射到构筑物后引起的涡流等情况，尽量减少短路循环和死角的产生，避免与池壁的正面撞击而降低流速。参照下面的运行模式图，可帮助您合理选择搅拌机和安装形式。

The installation and positioning of the submersible mixers will have great impact on the mixing effectiveness. In order to get twice result with the half the effort, We suggest the users follow the advice of professional designers and fully consider the pond shape, position of the water inlet and outlet, as well as the vortex resulting from the water flow from the mixer reflex to the structures, try to reduce the short-circuit circulation and dead corners, and avoid the dashing of the flow against the pond wall to retard the flow velocity, Refer to the following diagrams of operating modes, which can help you make a reasonable selection of the mixers and the installation modes



方形池Square pond



矩形池Rectangular pond



路道形池Road-shaped pond

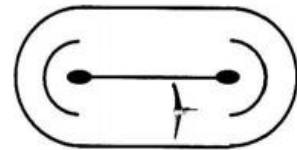

圆形池Circular pond



环形池Ring-shaped pond

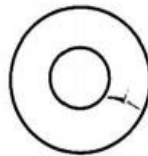

S曲线形池S-shaped pond

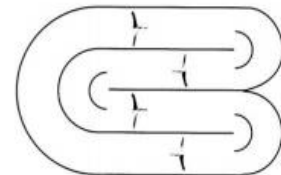

安装方式及尺寸 Installation Modes and Dimensions

潜水推流器可以有多种安装方式，这里提供两种最通用的方式供选择，尺寸可参考下表。我公司还可以根据用户的要求作特殊设计。

The submersible mixers can have multiple installation modes, Here are two generally accepted modes of installation for selection with reference to following table, Our company can also provide the special designs in accordance with the requirements of the users.

型号Type	a	D	b	L	H1min	H2min	安装系统 Installation system
QDTA1100/52/2-2.2/G	□100	Φ1100	210	1300	1000	270	IV
QDTA1100/63/2-3/G	□100	Φ1100	210	1300	1000	270	IV
QDTA1100/85/2-4/G	□100	Φ1100	210	1150	1000	270	IV
QDTA1400/34/2-2.2/G	□100/Φ89	Φ1400	210/600	1300/1050	800	125	IV/V
QDTA1400/43/2-3/G	□100/Φ89	Φ1400	210/600	1300/1050	800	125	IV/V
QDTA1400/52/2-4/G	□100/Φ89	Φ1400	210/600	1350/1050	800	125	IV/V
QDTA1400/63/2-5.5/G	□100/Φ89	Φ1400	210/600	1350/1050	800	125	IV/V
QDTA1800/34/2-3/G	□100/Φ89	Φ1800	210/600	1300/1050	800	125	IV/V
QDTA1800/43/2-4/G	□100/Φ89	Φ1800	210/600	1350/1050	800	125	IV/V
QDTA1800/47/2-5.5/G	□100/Φ102	Φ1800	200/600	1400/1050	800	125	IV/V
QDTA1800/52/2-7.5/G	□100/Φ102	Φ1800	200/600	1400/1050	800	125	IV/V
QDTA2100/34/2-3/G	□100/Φ89	Φ2100	210/600	1300/1050	900	125	IV/V
QDTA2100/43/2-4/G	□100/Φ89	Φ2100	210/600	1350/1050	900	125	IV/V
QDTA2100/47/2-5.5/G	□100/Φ102	Φ2100	200/600	1400/1050	900	125	IV/V
QDTA2100/52/2-7.5/G	□100/Φ102	Φ2100	200/600	1400/1050	900	125	IV/V
QDTA2500/34/2-3/G	□100/Φ89	Φ2500	210/600	1300/1050	1000	125	IV/V
QDTA2500/43/2-4/G	□100/Φ89	Φ2500	210/600	1350/1050	1000	125	IV/V
QDTA2500/39/2-5.5/G*	□100/Φ102	Φ2500	200/600	1400/1050	1000	125	IV/V
QDTA2500/43/2-7.5/G*	□100/Φ102	Φ2500	200/600	1400/1050	1000	125	IV/V
QDTA1100/52/3-3/G	□100	Φ1100	210	1300	1000	270	IV
QDTA1100/85/3-5.5/G	□100	Φ1100	210	1350	1000	270	IV
QDTA1400/43/3-3/G	□100/Φ89	Φ1400	210/600	1300/1050	800	125	IV/V
QDTA1400/52/3-7.5/G	□100/Φ102	Φ1400	200/600	1400/1050	800	125	IV/V
QDTA1800/34/3-3/G	□100/Φ89	Φ1800	210/600	1300/1050	800	125	IV/V
QDTA1800/43/3-5.5/G	□100/Φ102	Φ1800	200/600	1400/1050	800	125	IV/V
QDTA1800/52/3-7.5/G	□100/Φ102	Φ1800	200/600	1400/1050	800	125	IV/V
QDTA2100/34/3-4/G	□100/Φ89	Φ2100	210/600	1350/1050	900	125	IV/V
QDTA2100/43/3-5.5/G	□100/Φ102	Φ2100	200/600	1400/1050	900	125	IV/V
QDTA2100/47/3-7.5/G	□100/Φ102	Φ2100	200/600	1400/1050	900	125	IV/V
QDTA2500/43/3-5.5/G	□100/Φ102	Φ2500	200/600	1400/1050	1000	125	IV/V
QDTA2500/47/3-7.5/G	□100/Φ102	Φ2500	200/600	1400/1050	1000	125	IV/V

潜水推流器安装示意图 Installation diagram of Submersible flow propeller

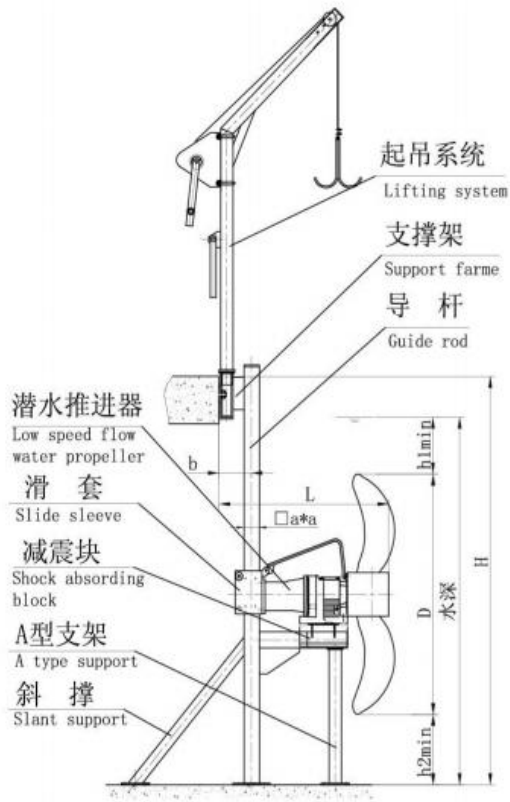

IV 单导轨型 Single-rail type

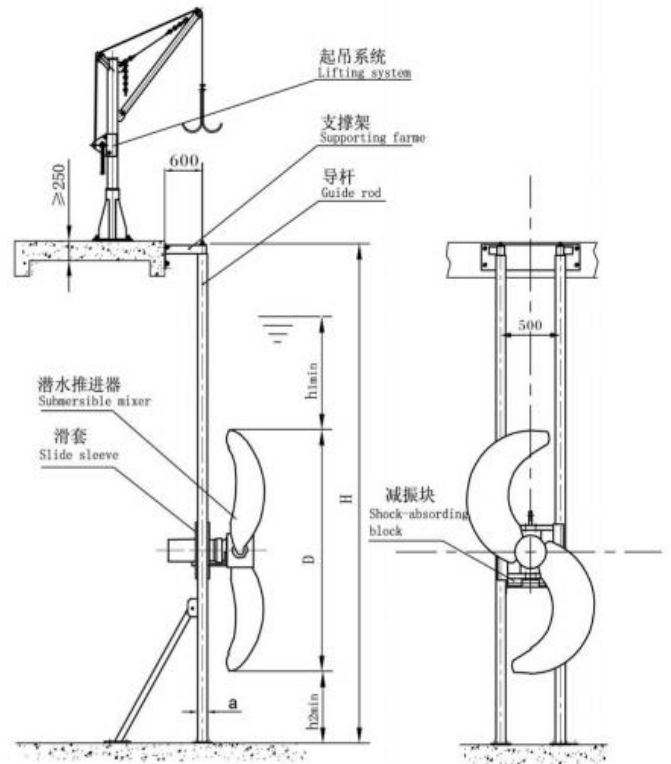

V 双导杆型 Double guide rod type





地址：南京六合经济开发区时代大道 69 号
Add: No.69 Shidai Avenue, Luhe Economic Development
Zone, Nanjing, P.R.China
电话 Tel: +86 25 57139086 86661665 57138396(总机)
传真 Fax: +86 25 57139096 86669839
[http:www.njbeite.com](http://www.njbeite.com)
E-mail:Beite@njbeite.com